



Replacing the Galaxy II CRT Monitor with a Flat Screen Monitor Kit # 42638

This kit contains detailed instructions on removing a Galaxy II Daewoo monitor and replacing it with a 19" wide flat screen monitor.

Note: If you are converting a Galaxy II that has serial number 3500 or older, you may be required to purchase additional components. Contact Arachnid for details.

Parts List

Item	Description	Part Number	Qty
A	LCD Flat Screen Monitor	42710	1
A	Monitor Bracket	42749	1
B	Bezel	42750	1
C	Template	42632	1
D	Template Locator Bushings	42635	2
E	Plastic Drill Bushing for Hot Button Reader	42636	1
F	Hot Button Reader push-nut	42639	1
G	Monitor VGA Cable	---	1
H	Red Sharpie Marker	---	1

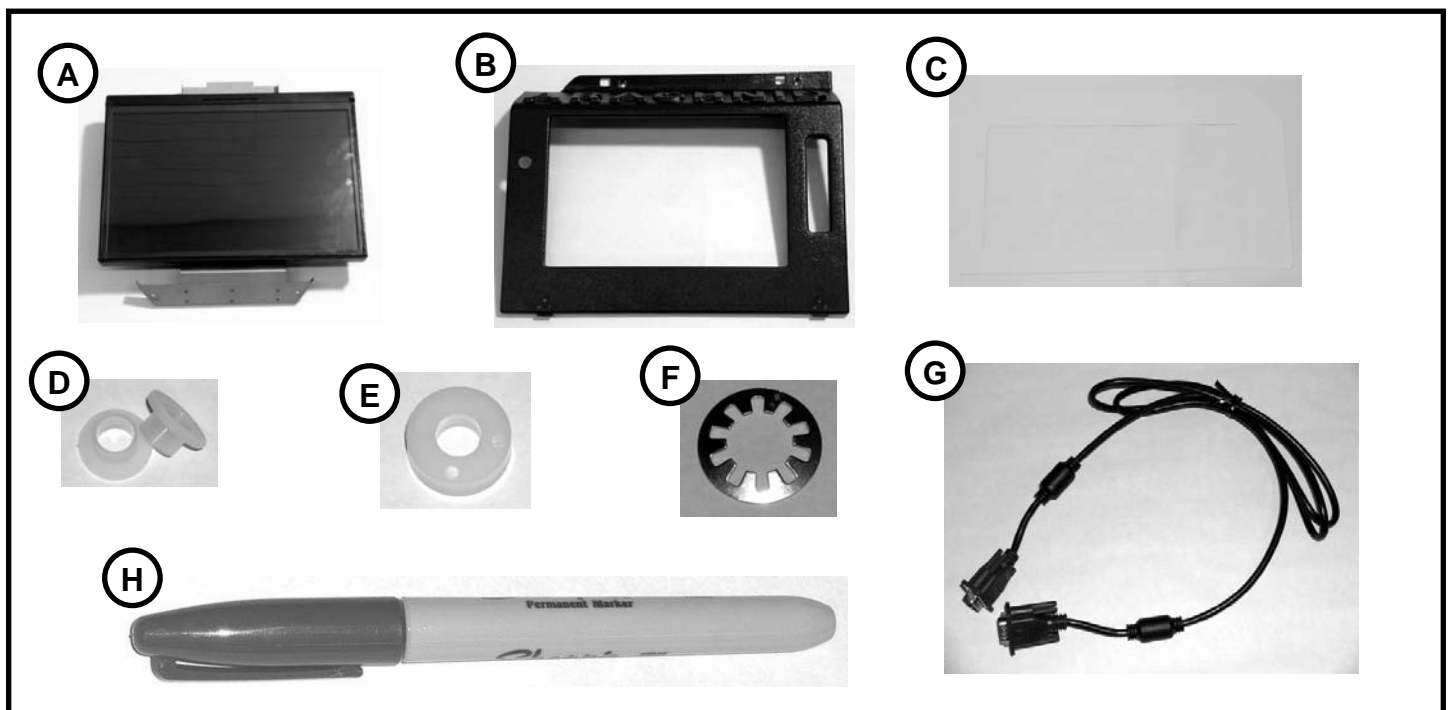

Tools And Supplies Required

- 1 - Flathead Screwdriver - Used to remove the Hot Button reader.
- 1 - Saber Saw - Used for cutting out the opening in the cabinet to make room for the LCD monitor.
- 1 - Drill with 3/8 drill bit - Used for new hot button mounting hole
- 3-4" - Adhesive tape (scotch or masking) - Used to temporarily secure the template

For safety reasons, never work on a Galaxy II that is plugged in.

Preparation Work

By following the instructions below, you get the Galaxy II ready to be modified for it's new 19" flat screen monitor.

- 1. Remove power from the Galaxy II.
- 2. Remove the VGA cable from the main board.
- 3. Remove the wireharness and any network and phone lines attached to the main board.
- 4. Remove the dart head door.
- 5. Remove the bezel.

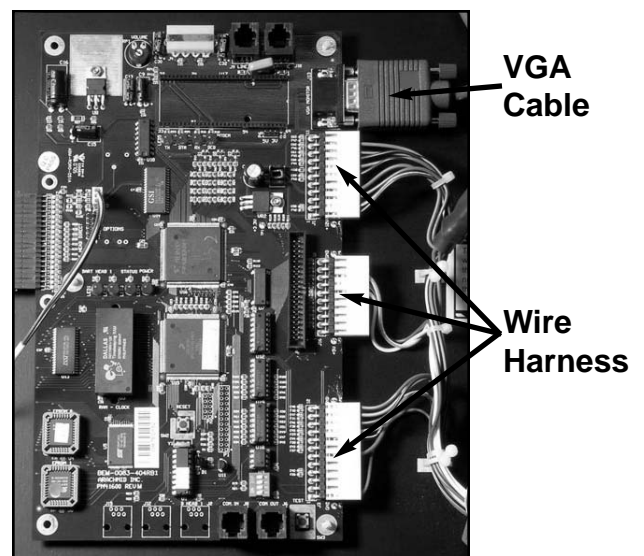

- 6. Remove the monitor restraint bracket.
- 7. Remove the monitor power cord from the Galaxy II power supply.
- 8. Remove the old monitor.

- 9. Remove the monitor power cord from the monitor. It will be used to power the new monitor.
- 10. Disconnect the Hot Button reader from the Galaxy II wire harness.

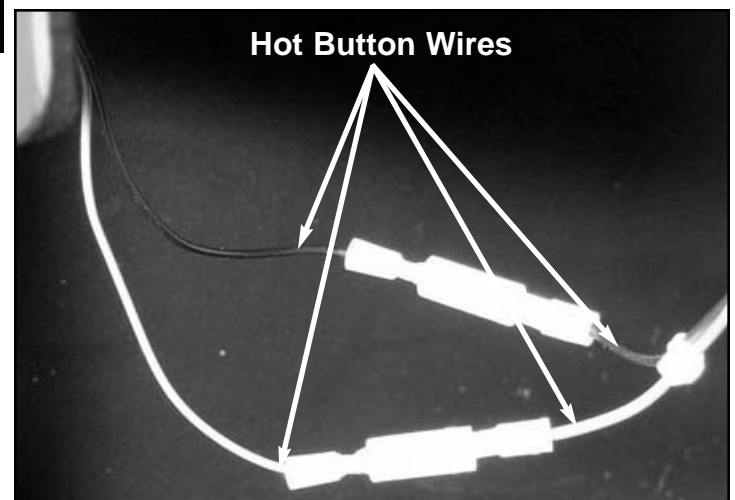

11. Remove the Hot Button reader.

- a. Gently pry out the front side of the reader. This will help loosen the push-nut on the interior of the cabinet. Take great care not to damage the reader.
- b. With the push-nut loosened, take a flat head screwdriver and pry it completely off the reader. Keep the plastic washer that is on the back of the reader, as it will be re-used.

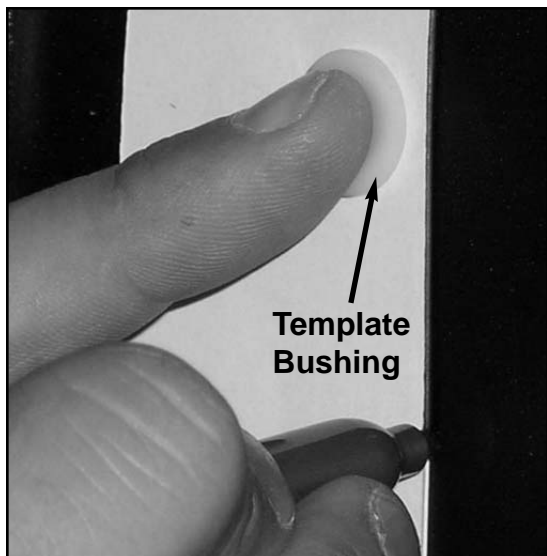
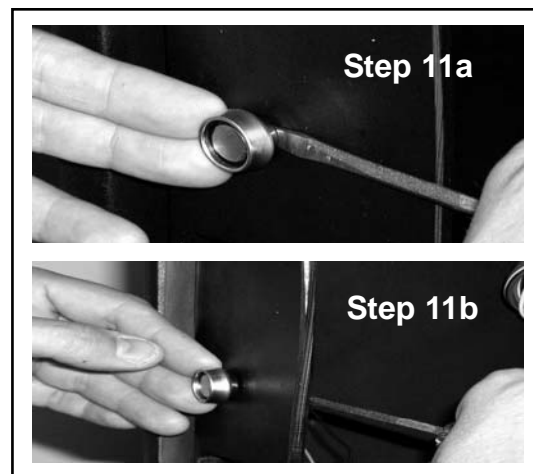

12. Place the template over the front face of the current monitor opening in the GII cabinet using the 3/8" holes as a guide.
13. Secure the template by inserting a plastic bushing into each of the holes.
14. Fold the top portion of the template back and tape both corners in place.
15. Trace the inside opening of the template with a red sharpie marker (supplied).
16. Remove the template.

Modifying the Galaxy II Cabinet and Bezel

The instructions below explain the process involved in changing the Galaxy II cabinet and bezel to fit the new 19" wide screen monitor.

Caution: Use proper safety precautions while performing these steps!

1. Cut the cabinet following the traced lines.

Important: Do not cut closer than 1/4" away from the two slits that held the monitor restraint bracket!

2. Clean the cutting chips and debris from inside the GII cabinet.

Note: For Galaxy II games below serial no. 14985 refer to instruction sheet number 42634 to properly add the enclosed cabinet hinges. This conversion may have already been performed on some games.

For Galaxy II's with serial numbers below 1992, you may be required to purchase additional components. Contact Arachnid for further details.

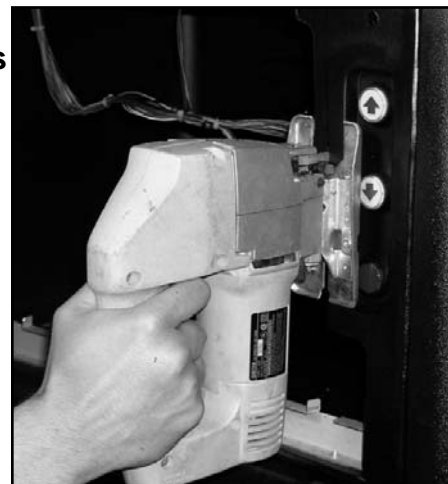

3. Install the new bezel.
4. Close and lock the bezel into place.
5. Insert the large plastic bushing (included) into the Hot Button clearance hole in the bezel.
6. Drill the cabinet using a 3/8" drill. Hold the bezel inward while drilling to prevent the bushing from coming loose.

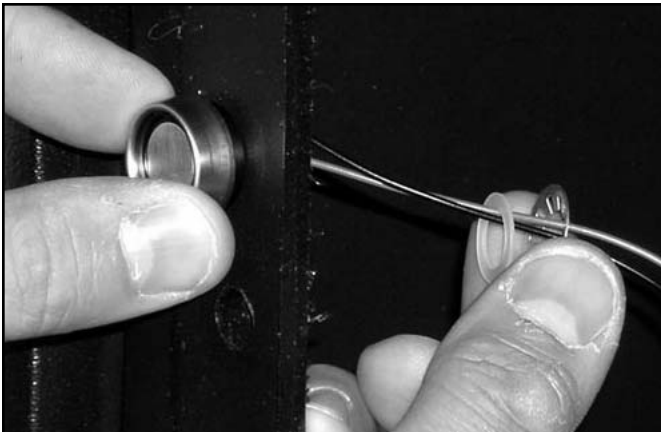

7. Open the bezel.
8. Re-install the Hot Button reader using the replacement push-nut and plastic washer saved from step 11b on page 3.
9. Plug the Hot Button reader back into the Galaxy II harness.

Attaching the Monitor Bracket to the Monitor

1. Remove the four thumb screws from the back of the monitor.
2. Attach the Monitor Bracket using the four thumb screws from step 1.

Note: Use the four lower holes on the bracket (the circled ones) to mount the monitor Bracket.

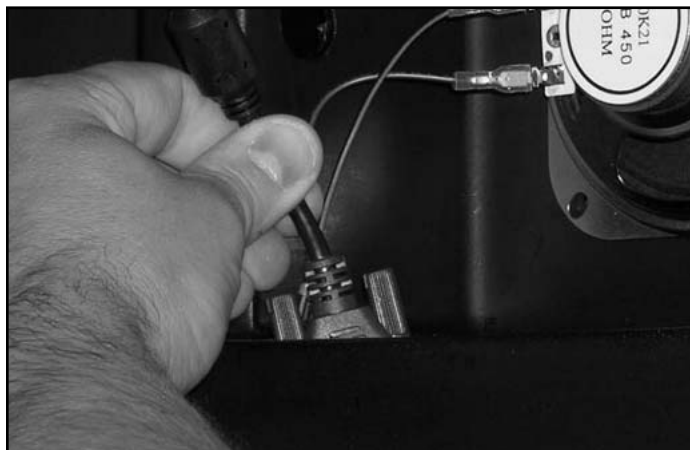
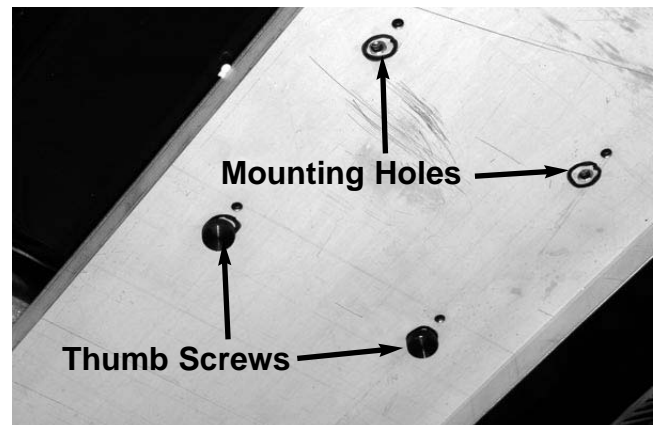

Installing the 19" Widescreen LCD Monitor

1. Re-install the darthead door.
2. Route the supplied VGA cable through the cabinet and attach it to the mainboard.

3. Carefully lay the new LCD monitor face down on a flat surface.
4. Insert the monitor power cord into the socket on the back side of the flat screen monitor.

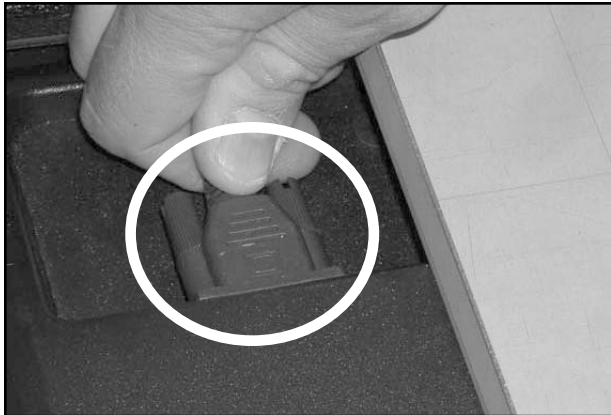

5. While holding the new monitor face down in front of the GII, attach the VGA cable to the flat screen monitor.
6. Attach the monitor power cord to the Galaxy II power supply.

Caution: Do not lay the flat screen on the lower bracket and take care not to drop the monitor!

7. Install the flat screen monitor.
 - a. The lower end of the new monitor bracket easily fits over the old monitor bracket.
 - b. The upper end drops into the angled slots for the old monitor restraint bracket.

Caution: Do not pinch the VGA and Power cables between the brackets.

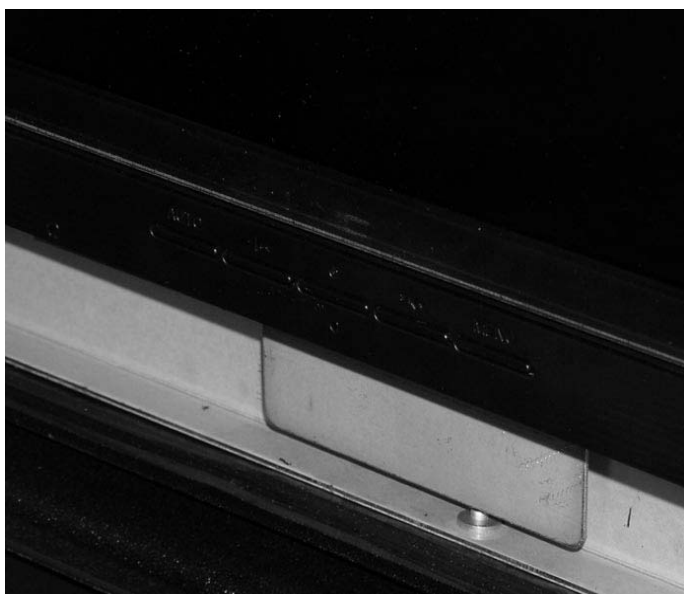

Monitor Bracket Bottom



Monitor Bracket Top



8. Re-attach wireharness.
9. Close the bezel.
10. Close the dart head door.

General Operation Instructions for the Monitor

The below instructions come from the monitors operation manual.



External Monitor Controls

1	Power Indicator	2	Power Button
3	▶	4	◀
5	Select	6	Menu
7	Auto	8	Power Light

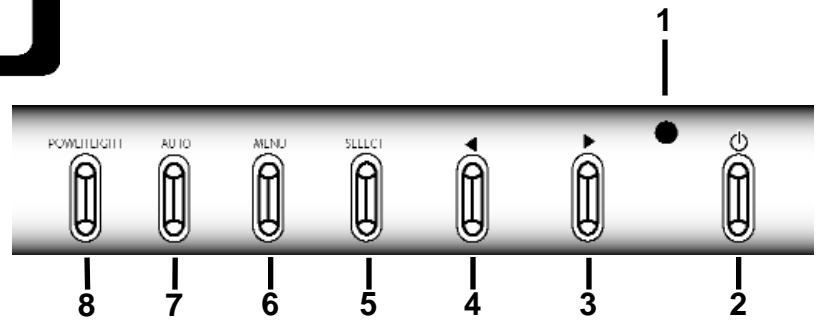

Notes:

- ◆ Do not install the monitor in a location near heat sources such as radiators or air ducts, or in a place subject to direct sunlight, or excessive dust vibration or shock.
- ◆ To keep monitor looking new, periodically clean it with a soft cloth. Stubborn stains may be removed with a cloth lightly dampened with a mild detergent solution. Never use strong solvents such as thinner, benzene, or abrasive cleaners, since these will damage the cabinet. As a safety precaution, always unplug the monitor before cleaning it.